



# ELGi Airmate Air Accessories

Total Compressed Air Solutions

**ELGi**  
Always Better.

**UPTIME™**  
ASSURANCE



CIN: L29120TZ1960PLC000351

[www.elgi.com](http://www.elgi.com)

Air Quality and Energy Saving



## A Tradition of Reliability

ELGi, established in 1960, designs and manufactures a wide range of air compressors. The company has gained its reputation for design and manufacture of screw compressors through strategic partnerships and continuous research and development. Over the years, it has emerged as a multi-product, multi-market enterprise providing total compressed air solutions in all segments. ELGi's design capabilities translated into a wide range of products ranging from oil-lubricated and oil-free rotary screw compressors, reciprocating compressors and centrifugal compressors. ELGi has its own manufacturing operations in India, Italy and USA with subsidiaries in Australia, Brazil, UAE and Indonesia. The company is fast expanding its global footprint attracting distributors and customers with its latest generation products.



## Robust Infrastructure

ELGi has modern manufacturing facilities equipped with advanced high precision grinding machines, turning centres and CNC horizontal and vertical machining centres. Screw airends are manufactured with the latest rotor grinding technology, coupled with measurement technology to maintain precise manufacturing tolerances. ELGi's manufacturing plants are both ISO and EOHS certified. The products are manufactured under controlled environment to ensure that its quality continues to meet the highest standards.



## Innovative Technology

Screw Compressor elements are manufactured in-house using state-of-the-art machining centres for rotor grinding and machining castings of various sizes. ELGi's own eta-V profile rotors ensure energy-efficient compressed air supply for all demanding applications. ELGi is one of the few companies capable of manufacturing wide range of airends and compressor packages in the world. ELGi's patent portfolio is a testament to the company's continuous research and innovation capability



# AIR UP.

**UPTIME™** comes standard on every airmate air accessories



### UPTIME Design

This speaks to the engineering and design of our products. Our R&D is dedicated to designing machines that run cooler, cleaner and longer... that are easy to service... with longer service intervals.



### UPTIME Components

For so many of our customers, seeing is believing. They know a quality-built machine when they see it. That's why every part on a ELGi compressor is a quality part. From our proprietary air ends, to our use of leak-free hoses and piping.



### UPTIME Assurance

Here is where we back our pledge, Our industry leading warranties, parts availability and call centers staffed by experts assure peace-of-mind to our customers.

# Prevent Real Life Problems with Elgi Airmate Refrigeration Air Dryers and Filters



**Real life problem 1**  
Unwanted Abrasive Sludge

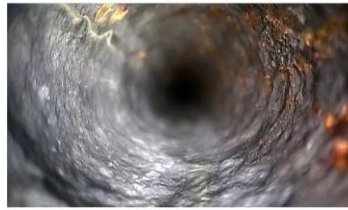

**Real life problem 2**  
Corrosion of Piping



**Real life problem 3**  
Damaged Pneumatic Tools

## Why do we need to dry the air?

When atmospheric air cools down, as happens following a compressor compression process, water vapour precipitates as condensate. This is the form of water that is naturally present in the air we breathe. Under average conditions, a compressor with a capacity of 3 m<sup>3</sup>/min at 7.5 bar will generate approximately 40 litres of water per day. This condensate needs to be removed from the compressed air system to prevent corrosion and damage to transmission piping and end use machines. Compressed air drying is hence essential and is an important part of air treatment process.

Compressed air will also contain water, dirt, wear particles, bacteria and even degraded lubricating oil. All these impurities mix together to form an abrasive sludge. This sludge is often acidic and accelerates wear and tear of tools, pneumatic machinery, block valves and orifices. This results in costly air leaks and high maintenance. It also corrodes pipes and can bring production process to a standstill.

Only compressed air that is totally clean and dry will ensure reliable working of compressed air systems and maximum savings. The favoured method of drying the compressed air is through refrigeration dryers.

Elgi offers a reliable solution through Elgi Airmate Refrigerant Air Dryers. The dryers ensure longer life of compressed air systems through efficient removal of the condensate and contaminants.

## Total Air Cure Solutions for clean and dry air

- 1

Ambient air of 3m<sup>3</sup>/min at 35°C with 60% RH contains 82 litres of water / day



- 2

Compression ratio 1:10 working volume of 0.3m<sup>3</sup>/min at 45°C will precipitate 61 litres of water/day & get removed by the moisture separator

- 3

Elgi Airmate Refrigerant Dryer and Filter will remove 19 to 20 litres of water / day

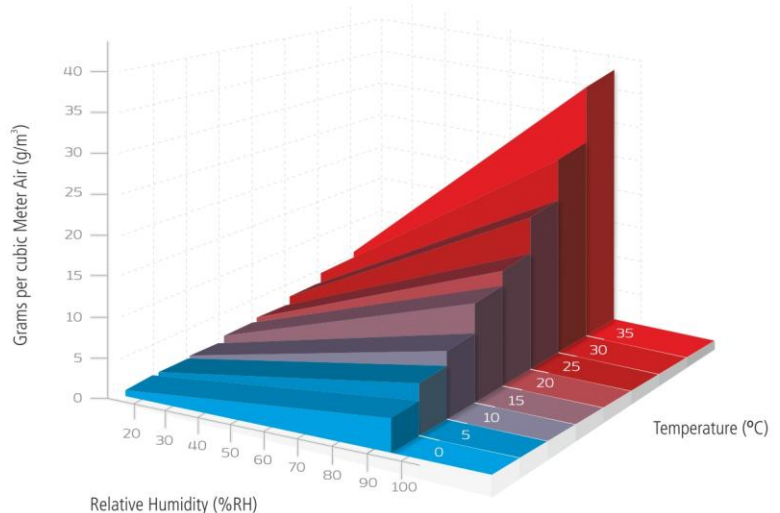



Adding value to the Elgi Compressor range  
**Elgi Air Accessories**

## Cycle controller

The pressure operated 100% modulating cycle controller provides a quicker and reliable response to the inlet air temperature. It ensures optimum dew point control under all operating conditions. It is primarily used to prevent freezing phenomenon in the evaporator. Mechanical type cycle controller is used in the higher flow models and solenoid operated cycle controller is used in lower flow models.

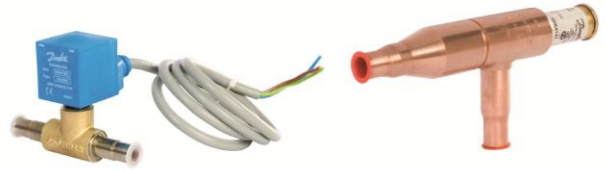

## Controller

The use of microprocessor based controller ensures higher performance reliability of the drier. The controller indicates the pressure dew point for online monitoring. Setting options for controlling the cycle controller and automatic drain valves are provided.

## Refrigeration compressor

Hermetically sealed and highly energy efficient reciprocating piston compressor ensures effective compression of the refrigerant for drying the compressed air.



## Condenser

Highly efficient copper tubed Aluminum finned condenser. The hot and high pressure refrigerant enters into the condenser in gaseous state and gets cooled through the forced circulation of cold air using a fan and flows to the expansion valve in liquid state.



## Installation of Air Accessories

### Compressed Air Supply System

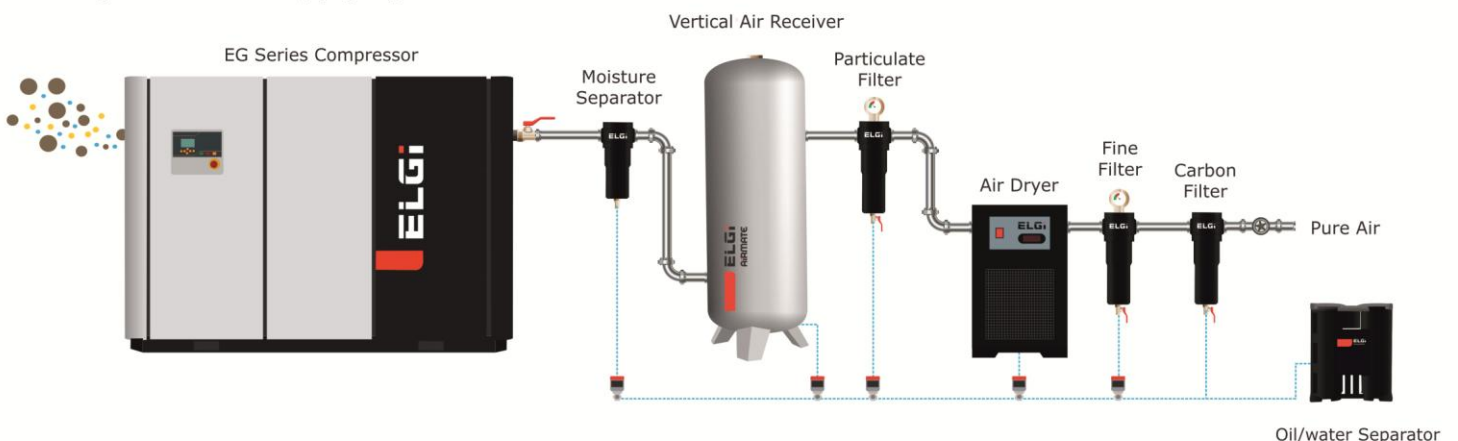

### Capillary/Expansion Device

Use of capillary refrigerant expander or mechanical expansion device prior to the heat exchanger ensures that the refrigerant flow into the evaporator is only in the liquid state. High quality copper ensures minimum due point fluctuation and maximum heat transfer efficiency between compressed air and refrigerant.



### Heat exchanger

High efficiency 'tube in tube' heat exchanger. The high quality copper tube ensures maximum heat transfer efficiency, corrosion resistance and minimum pressure drop. The heat exchanger is filled with PUF for better insulation and efficiency. It performs the function of both pre-cooler and evaporator.

### Condensate drain

High reliability automatic condensate drain ensures maximum condensate removal from the system. The drain is solenoid controlled and the timings of moisture draining can be set by the user using the microprocessor based controller. This controllable feature ensures reliable moisture cured air even at high humid and tropical conditions.



## Airmate Refrigeration Air Dryer



### Ozone-friendly refrigerant

Elgi thinks long run to make the earth and the environment a safer and a better place to live. As per international protocol, Elgi uses ozone-friendly R 134A gas as the refrigerant which has zero ozone-depletion potential.

# ELGI Refrigeration Air dryer Schematic diagram

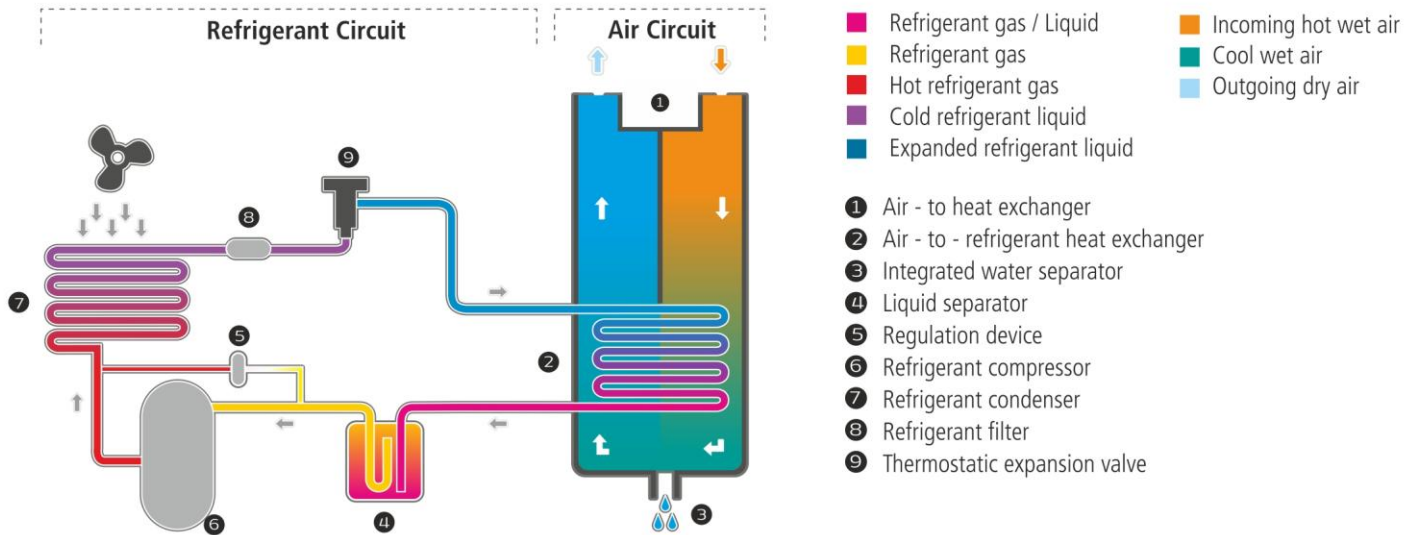

Model	Flow		Max Pressure bar g	Electrical			Dimensions in mm			Weight Kg	Cooling media	End Connections
	cfm	m <sup>3</sup> /min		Volts	Hz	phase	length	breadth	height			
ELRD 010	10	0.28	16	230	50	Single	360	475	570	45	Air	1/2" BSP
ELRD 020	20	0.57	16	230	50	Single	360	475	570	45	Air	1/2" BSP
ELRD 030	30	0.85	16	230	50	Single	360	475	570	47	Air	1/2" BSP
ELRD 040	40	1.13	16	230	50	Single	360	475	570	47	Air	1/2" BSP
ELRD 150	150	4.25	16	415	50	Three	600	800	850	135	Air	1" NB FLG
ELRD 200	200	5.66	16	415	50	Three	600	800	850	135	Air	1½ NB FLG
ELRD 300	300	8.50	16	415	50	Three	800	900	1150	200	Air	1½ NB FLG
ELRD 400	400	11.33	16	415	50	Three	800	900	1150	250	Air	2" NB FLG
ELRD 500	500	14.16	16	415	50	Three	800	1000	1350	250	Air	2" NB FLG
ELRD 600	600	16.99	16	415	50	Three	800	1000	1350	275	Air	2" NB FLG
ELRD 750	750	21.24	16	415	50	Three	900	1200	1475	375	Air	3" NB FLG
ELRD 900	900	25.48	16	415	50	Three	900	1200	1725	425	Air/ Water	4" NB FLG
ELRD 1100	1100	31.15	16	415	50	Three	900	1200	1725	425	Air/ Water	4" NB FLG
ELRD 1254	1254	35.51	16	415	50	Three	900	1200	1725	1000	Air/Water	4" NB FLG
ELRD 1552	1552	43.95	12.5	415	50	Three	1300	1800	1650	1200	Air/Water	5" NB FLG
ELRD 1750	1750	49.55	12.5	415	50	Three	1300	1800	1650	1500	Air/Water	5" NB FLG
ELRD 2000	2000	56.63	12.5	415	50	Three	1300	1800	1900	1600	Air/Water	6" NB FLG

Dryer Rated condition - Working Pressure 7 bar, inlet temperature 45°C, ambient temperature 35°C, pressure dew point +3°C

Customized models are available on request

Dryers of higher capacities are also available

Due to continuous engineering improvements, technical specifications are subject to change without prior notice

## Correction factors

Inlet temp.	25°C	30°C	35°C	40°C	45°C	50°C	55°C	60°C
factor	1.22	1.20	1.15	1.05	1	0.85	0.8	0.7

Ambient temp.	20°C	25°C	30°C	35°C	40°C	45 °C	50°C
factor	1.20	1.14	1.10	1	0.91	0.87	0.78

Working Pressure	4 bar g	5 bar g	6 bar g	7 bar g	8 bar g	9 bar g	10 bar g	11 bar g
factor	0.75	0.85	0.93	1	1.06	1.11	1.15	1.18

# Airmate Desiccant Dryer



**Principle of Operation** A heatless twin tower desiccant dryer operates by removing moisture through adsorption onto a granular desiccant bed from the air supply. As compressed air flows up through a packed bed of desiccant in tower 1, water vapor is adsorbed. Meanwhile tower 2 is rapidly depressurized and dry purge air from the outlet of tower 1 is fed through a purge valve, expanded to near atmospheric pressure, and counter-flowed down through tower 2 to effect the regeneration of its granular desiccant bed. When the desiccant in tower 1 becomes saturated with water vapor the air supply is switched back to tower 2 after it has been re-pressurized and the cycle continues.

**As default, all HLD models above 5X are provided with the following options.**

### Dew Point Stretch Cycle:

It stretches the moisture loading time of the desiccant bed by increasing the drying time. A dew point meter at the outlet with a required dew point setting provides the signal for the stretch cycle. This reduces the purge air in accordance to the air flow and dew point chosen. The purge occurs for the pre-programmed time during this time. Note - Dew point meter not in dryer scope.

### Purge Optimizer:

It reduces the percentage of regeneration flow based on the front panel setting. It has 4 options 40%, 60%, 80% & 100% purge optimization cycles respectively. The settings correspond to flow or moisture load through the dryer. Separate LED Indicators for Tower Status, Purge Optimizer & Condensate Drain

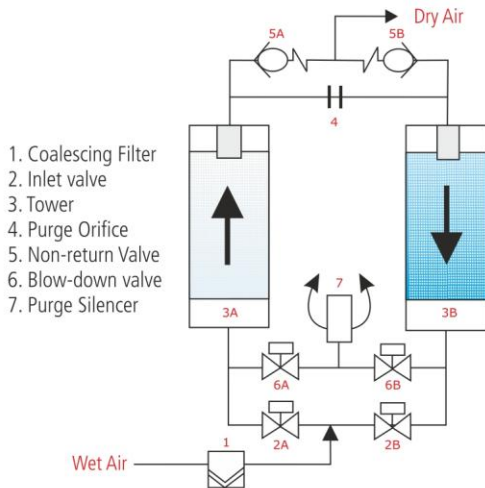

Specification	
Air Inlet Condition	Maximum Fluid Temp. 50°C
Cycle Time	4 Minutes
Regeneration Volume	12 ±1%
Pressure Dew Point @ outlet	-20°C
Operating Voltage	85 - 265 V 50 / 60 hz 1 Ph
Outlet Air Quality Class	ISO 8573 - 2010 (Class 3*)

\* Class 1 and 2 available on request

Model#	Flow cfm	Max. Working Pressure (bar)	End Connection BSP	Dimensions (mm)			Weight Kgs	Pre Filter Rating μ	Desiccant Media Type
				H	W	D			
HLD 1X	10	12.5	½"	675	335	280	11	0.3	Activated Alumina
HLD 2X	20	12.5	½"	106	335	280	16	0.3	
HLD 3X	30	12.5	½"	880	420	181	28	0.3	
HLD 5X	45	12.5	½"	1110	420	181	34	0.3	
HLD 8X	75	12.5	1"	1192	523	313	61	0.01	Activated Alumina & Molecular Sieves
HLD 10X	100	12.5	1"	1603	439	372	106	0.01	
HLD 13X	125	12.5	1"	1913	439	372	119	0.01	
HLD 20X	200	12.5	1½"	1615	449	582	214	0.01	
HLD 25X	250	12.5	1½"	1925	449	582	238	0.01	Activated Alumina
HLD 30X	300	12.5	2"	1615	457	764	256	0.01	
HLD 38X	375	12.5	2"	1925	457	764	286	0.01	
HLD 50X	500	12.5	50NB	1623	1542	900	960	5.00	
HLD 70X	700	12.5	80NB	1865	1930	1000	1265	5.00	Activated Alumina
HLD 100X	1050	12.5	80NB	1865	1930	1000	1575	5.00	

Dryer Rated condition - Working Pressure 7 bar, Inlet temperature 45°C, ambient temperature 35°C, pressure dew point -20°C  
# Due to continuous engineering improvements, specifications are subject to change.

### Inlet Pressure Correction Factor

bar (g)	4	5.5	7	8.3	9.7	11	12.4
CF	0.65	0.83	1	1.18	1.37	1.52	1.7

### Air Inlet Temperature

°C	32	35	40	45	50
CF	1.55	1.33	1.15	1.00	0.74

### Dew Point Correction Factor

PDP	-70	-40	-20	-10	3
CF	0.53	0.8	1	1.1	1.21

# Airmate Air Receiver



The Elgi Air Receiver is engineered to handle the stress of fluctuating air demands, reduce wear and tear and increase the life of the end use equipment.

Model	Capacity		Max Working Pressure bar g	Dimensions (mm)		End Connections
	ltr.	m <sup>3</sup>		Height	Dia.	
VA 00 010	250	0.25	12.5	1745	500	3/4" NPT
VA 00 020	500	0.5	7	2060	600	1 1/2" NPT
VA 00 020	500	0.5	10	2060	600	1 1/2" NPT
VA 00 020	500	0.5	12.5	2010	622	1 1/2" NPT
VA 00 030	750	0.75	12.5	2095	752	2" NB FLG
VA 00 040	1000	1	7	2700	750	2" NB FLG
VA 00 040	1000	1	10	2700	750	2" NB FLG
VA 00 040	1000	1	12.5	2700	750	2" NB FLG
VA 00 060	1500	1.5	7	2510	996	2" NB FLG
VA 00 060	1500	1.5	10	2510	996	2" NB FLG
VA 00 060	1500	1.5	12.5	2520	1020	2" NB FLG
VA 00 080	2000	2	7	3185	1000	2" NB FLG
VA 00 080	2000	2	10	3185	1000	2" NB FLG
VA 00 080	2000	2	12.5	3185	1000	2" NB FLG
VA 00 120	3000	3	7	2995	1310	2" NB FLG
VA 00 120	3000	3	10	2995	1310	2" NB FLG
VA 00 120	3000	3	12.5	2815	1314	2" NB FLG
VA 00 160	4000	4	12.5	3590	1314	4" NB FLG
VA 00 200	5000	5	12.5	3545	1500	4" NB FLG

Dimensions are approximate

Air receivers of higher capacities are available on request

Air receivers are made as per IS 2825. Consult Marketing for specific certification requirements.

Level sensing auto drains are also available as an option

Due to continuous engineering improvements, technical specifications are subject to change without prior notice

## Airmate Filters



ISO 8573 - 1

### Alocrom aluminium treatment

The Alocrom aluminium treatment is a special feature of all Elgi Airmate die-cast filter housings. This treatment ensures there is no corrosion and no carry over of corroded particles into the airline, which can otherwise cause blockades in sophisticated parts.

### TYPE PF (Particulate Filter)

#### High efficiency General Purpose

#### Protection: For the removal of particles

down to 1 micron including coalesced liquid water and oil, providing a maximum remaining oil aerosol content of 0.5 mg/m<sup>3</sup> @ 21°C.

### TYPE FF (Fine Filter)

#### High Efficiency Oil Removal Filtration:

For the removal of particles down to 0.01 micron including water and oil aerosols, providing a maximum remaining oil aerosol content of 0.01 mg/m<sup>3</sup> @ 21°C. (Precede type FF with type PF)

### TYPE CF (Carbon Filter)

#### Activated Carbon Filtration: For the removal of oil

vapour and hydrocarbon odour giving a maximum remaining oil content of <0.003 mg/m<sup>3</sup> (<0.003 ppm) (excluding methane) @ 21°C. (Precede type CF with type FF & PF)

### Technical Data

Maximum operating pressure (0020 to 2120) with Autodrain	16 bar g (232 psi g)	Max. recommended operating temperature 30°C (86°F) (Type CF)	Initial 'dry' differential pressure Type PF - 40m bar (0.58 psi) Type FF - 120m bar (1.74 psi) Type CF - 80m bar (1.16 psi)	Initial 'wet' differential pressure Type PF - 140m bar (2.0 psi) Type FF - 200m bar (3.0 psi) Type CF - N/A
Maximum operating pressure (0020 to 2120) with manual drain	20 bar g (290 psi g)			
Maximum recommended operating temperature (Type PF/FF)	66°C (150°F)	Maximum recommended pressure differential for element change: (PF, FF filters only) 400m bar.		





CLEARANCE TO CHANGE ELEMENT

## Economy Series Filters

Filter Type (PF,FF,CF)	End Connections	Flow rates @ 7 bar g (100 psi g)		Dimensions (mm)				Weight (kg)
		cfm	m <sup>3</sup> /h	H	W	C	D	
(Filter Type)E 0018	G 3/8	18	31	275	70	180	75	1.2
(Filter Type)E 0035	G 3/8	35	59	315	80	215	90	1.3
(Filter Type)E 0053	G 1/2	53	90	315	80	215	120	1.5
(Filter Type)E 0070	G 1/2	70	119	350	95	235	120	1.6
(Filter Type)E 0105	G 3/4	105	178	350	95	235	150	1.8
(Filter Type)E 0125	G 1	125	212	420	110	295	150	1.8
(Filter Type)E 0160	G 1	160	272	420	110	295	150	2.5
(Filter Type)E 0210	G 1 1/4	210	357	420	110	295	200	2.7
(Filter Type)E 0280	G 1 1/2	280	476	575	150	405	200	5
(Filter Type)E 0420	G 2	420	714	575	150	405	280	6
(Filter Type)E 0620	G 2	620	1053	1015	280	830	450	28
(Filter Type)E 0840	G 2 1/2	840	1427	1015	280	830	580	33
(Filter Type)E 1120	G 3	1120	1903	1315	320	1120	850	40
(Filter Type)E 1700	G 4	1700	2888	1100	410	710	580	80
(Filter Type)E 2540	G 4	2540	4315	1100	410	810	580	80
(Filter Type)E 3300	G 4	3300	5607	1370	410	1140	850	90

0018 - 0620 : Threaded end connection with manual drain / 0840 - 3300 : Flanged end connection with manual drain  
Due to continuous engineering improvements, technical specifications are subject to change without prior notice

### For Flow Rates at other pressures, apply the factor shown

Line pressure in bar. g	1	2	3	5	7	9	11	13	15	17	20
Correction Factor	0.38	0.53	0.65	0.85	1.0	1.13	1.25	1.36	1.46	1.56	1.7

The CF Filter will not remove CO/CO or other toxic gases or fumes.

Ordering example: To order fine filter with a flow capacity of 125 cfm at 7 bar, specify FFE0125

## Airmate Moisture Separator



Maximum operating pressure: 16 bar g (232 psi g)  
Maximum recommended operating temperature: 66°C (150°F)  
Minimum recommended operating temperature: 1.5°C (35°F)  
Typical pressure differential at rated flow: 20 - 60 m bar (0.3 - 0.9 psi)

Line Pressure	bar g	1	3	5	7	9	11	13	15	16
	psi g	15	44	73	100	131	160	189	218	232
Correction Factor		0.5	0.71	0.87	1.0	1.12	1.22	1.32	1.41	1.56

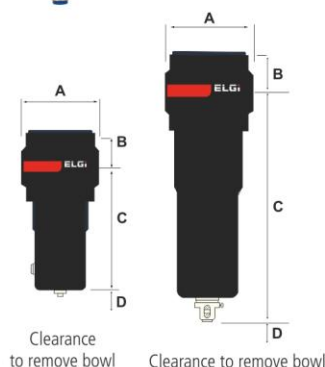

Model*	Inlet/Outlet Connections	Flow Rates @ 7 bar g (102 psig)		Dimensions in mm				Weight Kg
		cfm	m <sup>3</sup> /min	A	B	C	D	
MS100	G1/2	100	2.83	95	21	236	130	1.25
MS150	G 3/4	150	4.25	95	21	236	130	1.25
MS365	G1½	365	10.34	122	33	267	180	2.80

\* For NPT connections suffix Model No. with NPT  
Larger sizes on request

# Oil - Water Separator

When the air is compressed through compressor, it results in condensate along with compressed air. Condensate – A mix of water, oil & dust particles. If not treated properly and releasing it to the environment, this condensate can make detrimental effects of environment. Regulatory bodies for effluent treatment recommend that these condensate should be cleansed before releasing it to the sewage disposal.

ELGi EOS series is specifically designed to maintain less than 10ppm of oil in the condensate before allowing the fluid to pass on to the environment. Thanks to the multi-Level separation process with both super efficient fiber adsorbent and Activated carbon, which ensures the contaminant levels are kept well within the statutory requirements.



## Technical Specifications

Model	Maximum Compressor Capacity	Maximum Oil adsorption capacity	No. of Inlet ports	Inlet & Output port sizes	Package (LxBxH)	Gross Weight
	cfm	Litres	Nos	Inch-BSP	mm	kg
EOS - 7	70	2	1	1/2" x 1/2"	245 x 221 x 230	3
EOS - 13	125	3	1	1/2" x 1/2"	380 x 203 x 370	8
EOS - 18	175	5	2	1/2" x 1"	559 x 184 x 588	10
EOS - 35	350	10	2	1/2" x 1"	625 x 230 x 723	19
EOS - 70	700	15	2	1/2" x 1"	760 x 294 x 867	32
EOS - 110	1060	25	2	1/2" x 1"	933 x 368 x 867	45
EOS - 210	2100	50	2	1/2" x 1"	1160 x 480 x 1040	70

# Airmate Drain Valves

## "Zero loss advantage"

Compressed air condenses moisture in dryers, after-coolers and air receivers. This condensate needs to be removed frequently. This process is done by the drain valves. In ordinary drains, there is always loss of compressed air. Most of the condensate drains have a 4 mm orifice. This 4 mm orifice bleeds about 34 cfm, which is the equivalent of 6.5 kw of power. Elgi airmate drains work on the principle of zero air loss and do not bleed your compressed air, consequently saving energy.

## Technical Specifications

Capacity : 50 to 2000 cfm  
 Working pressure : 16 bar g max  
 Media : Condensate

### Compact Timer Drain Valve



The controller is built with ultra reliable microcontroller with dual adjustment of both both cycle and drains for added flexibility of use. The valve has large orifice and special solenoid operator section to discharge dust.

- Easy to mount at all location
- Maintain and clean drain valve without removing from service
- Adjustable on and off timing
- Large orifice for effective drain of dust and condensate
- Condensate discharging is no problem

### Level Sensing Drain Valve



The condensate sensing type automatic drain valve is the latest advancement in drain valve technology. Instead of operating through cycle timer, these valves sense the condensate level for activation, ensuring absolutely no loss of compressed air and hence enormous energy saving. These drain valves are highly efficient and reliable. They can be fitted directly on the equipment simply by replacing the manual drains.

- The electronic level control ensures proper draining of condensate and avoids unnecessary loss of air.
- All the functions of the valve are accurately indicated by the LED display.
- Test switch (or) manual drain allows function test at anytime.
- Intelligent Controller detects valve, probe failure and acts accordingly.
- Noise free, as air is not discharged.

# Energy Saving Solutions



## Energy saving - The CONSERVE way

### **CONSERVE™** ENERGY EFFICIENCY Variable Frequency Drives(VFD)

ELGI CONSERVE drives match output with demand by varying motor speed. the power consumption reduces in line with the reduction in demand. Helps in eliminating the frequent load-unload cycle and the also the wasted power from the energy bill.

A fixed speed compressor operates on a load-unload band of atleast 10 psi around the working pressure whereas with ELGI VFD, compressor can be operated within a band of 2 psi. Since compressors are not operated under higher than working pressure requirements, there is substantial energy saving. For every 2 psi reduction in operating pressure, there is 1% power saving.

In a fixed speed compressor with Star-Delta starter, starting current is as high as three times the full load current (FLC). With Elgi VFD starting, starting current is as equal to the full load current (FLC). This helps to avoid using heavy rated components like fuses, MCCB, cable size, generator rating, isolators etc.

For compressed air systems with fluctuating demand pattern, return on investment due to power saving will be less than 12 months

## 10 Year Life Cycle Cost

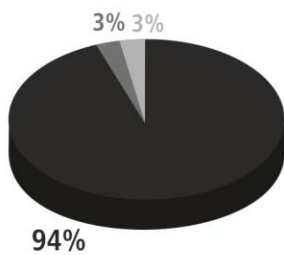

94%

Compressor without VFD

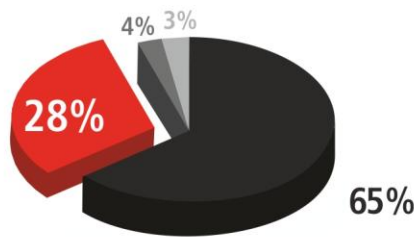

65%

Compressor with **CONSERVE™** ENERGY EFFICIENCY

■ Electricity ■ VFD Saving  
■ Equipment ■ Maintenance

### Advantages

#### Mechanical

- Minimum maintenance
- Smooth start
- Smooth control

#### Electrical

- Low starting current
- High efficiency
- Improved power factor
- Reduced maximum demand

Model	Compatible Compressor Model
ELVD 11-ELVD 75	EG11-75 & EE75
ELVD 90	EG 90 & EE90
ELVD 110	EG 110 & EE110
ELVD132	EG 132 & EE132
ELVD 160	EG 160 & EE160
ELVD 200	E200
ELVD 250	E250

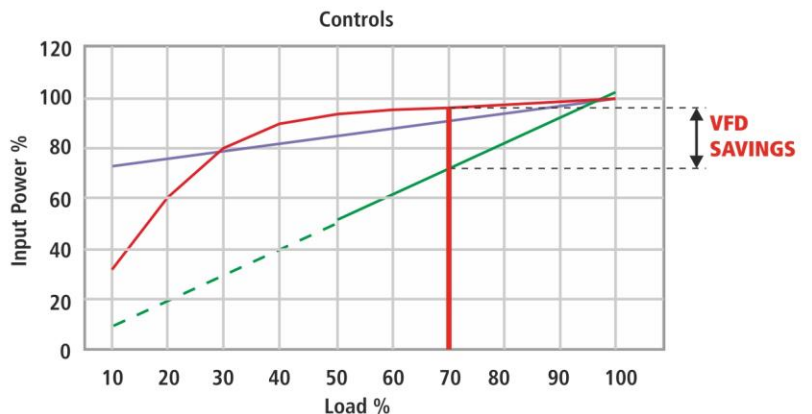

**Example: For a demand of 70 % of full load, the savings from Elgi Conserve compared to a fixed speed compressor will be about 28% of full load power**

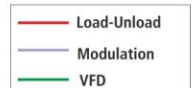

# Compressed air solutions for all sustainable air needs



**Oil-Free Series Screw**  
90 - 450 kW / 480 - 2515 cfm



**EG Series Rotary Screw**  
11 - 250 kW / 47 - 1612 cfm



**EN Series Rotary Screw**  
2.2 - 75 kW / 8.0 - 469 cfm



**Electric Portable (Trolley)**  
22 - 75 kW / 131 - 490 cfm



**Diesel portable (Trolley)**  
185 - 1100 cfm / 100 - 300 psi



**Diesel Portable (Skid)**  
475 - 1500 cfm / 150 - 400 psi



**Oil-free Recip**  
1.0 - 75 HP / 1.8 - 300 cfm



**Oil-lubricated Recip**  
1.0 - 40 HP / 2.0 - 128 cfm

## OVERSEAS OFFICES:

**Bangladesh** : ELGI Equipments Limited, 5th Floor, Planners Tower, Level: 5 Suite: 8-13, 13/A Bir Uttam CR Datt Road, Sonargaon, Dhaka-1000. Bangladesh. **T:** 880-9671453-65, **F:** 880-28616148, **E:** bangladesh-enquiry@elgi.com

**Malaysia** : ELGI Equipments Limited, No 2A-4-6, Jalan Jubli Perak, 22/1, Section 22, 40400, Shah Alam, Malaysia, **T:** +603 55693544, **F:** +603-55693544, **E:** malaysia-enquiry@elgi.com, **w:** www.elgi.com.my

**Srilanka** : S.G. Arcade, 2nd Floor, No.441, Sri Sangaraja Mawatha, Colombo-10, **T:** 00 - 94-11-2392425, **F:** 00-94-11-4737412. **E:** elgisupport@slnet.lk

**Thailand** : ELGI Equipments Limited, 223/66 Country Complex A 14th Floor, Sanphawut Road, Bangna Bangkok - 10260. **T:** +6627455160 **E:** thailand-enquiry@elgi.com, **w:** www.elgi.co.th

## WHOLLY OWNED SUBSIDIARIES

**Australia** : ELGI Equipments Australia Pvt Ltd., 38. Richland Avenue, Coopers Plains QLD 4108 Australia. **T:** +61-7-3106 0589, **F:** +61-7-3106 0537, **E:** Enquiry@elgi.com.au, **w:** www.elgi.com.au

**Brazil** : ELGI Compressores Do Brasil Ltd., Av. Emilio Checchinato, 4195 - B: Cep : 13295 - 000, Bairro: Sao Roque da Chave: Itupeva - SP, Brazil. **T:** 4496 5519, 4496 6611, **E:** contacto@elgi.com.br, **w:** www.elgi.br

**China** : **ELGI Equipments (Zhejiang) Limited**, No.232, Yunhai Road, Economic Development Zone, Jiaxing 314033 P. R. China **T:** +86-573-82079100 Hotline: 400-826-3585 | **ELGI Compressors Trading (shanghai) Co. Ltd.**, Rm 909, LSHQ International Centre, 288 Hongjing Road, Shanghai 201103, P. R. China **T:** +86-21-33581191 Hotline: 400-826-3585, **E:** enquiry.cn@elgi.com, **w:** www.elgi.com.cn

**Indonesia** : PT ELGI Equipments Indonesia, Kawasan Pergudangan, BIZPARK Commercial Estate, Pulogadung Jl. Raya Bekai KM 21, 5 Blok A3 No.12, Kel. Rawa Terate, Kec. Cakung, Pulogadung Jakarta Timur 13920. **T:** +62-21-46822216, 46827388, **E:** indonesia-enquiry@elgi.com, **w:** www.elgi.co.id

**Italy** : ELGI Compressors Italy S.r.l., Rome(RM), Via Del Babuino 51, 00187 : ROTAIR Spa, Via Bernezzo 67, 12023 Caraglio (CN), Italy. **T:** +39 0171619676, **F:** +39 0171619677, **E:** info@rotairspa.com

**Middle East** : ELGI Gulf (FZE), P.O. Box: 120695, Q4-081, SAIF Zone, Sharjah, U.A.E. **T:** +971 6 557 9970, **F:** + 971 6 557 9980, **E:** gulfenquiry@elgi.com

**USA** : ELGI Compressors USA, Inc. 1500-N Continental Blvd, Charlotte, NC 28273. **T:** +1-704-943-7966, **M:** +1-803-427-7985, **W:** www.elgi.us

# ELGI

**ELGI EQUIPMENTS LIMITED**

**CORPORATE OFFICE:** Trichy Road, Singanallur, Coimbatore - 641005,

**T:** +91-422-2589555, **E:** enquiry@elgi.com, **w:** www.elgi.com

Customer care mobile no.: +91 92821 11224 (SMS only)

Toll-free no: **1800-425-3544** (applicable for India only)

Distributed by

